

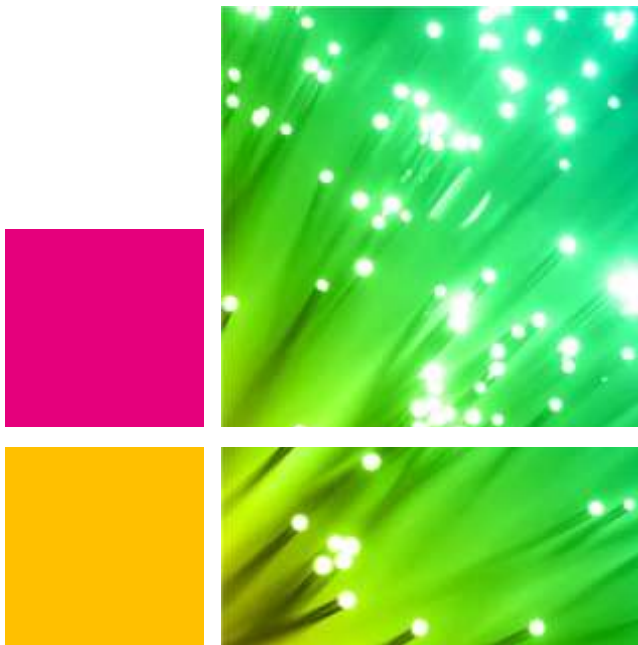

Department for
Digital, Culture,
Media & Sport

 Department for Digital, Culture, Media & Sport

**GIGABIT BROADBAND
VOUCHER SCHEME**



Supplier Registration Terms and Conditions

Gigabit Broadband Voucher Scheme

19/12/2018

Version **4.1**



Introduction

The Gigabit Broadband Voucher Scheme (the “**Scheme**”), is part of the Local Full Fibre Networks (“**LFFN**”) Programme. The Programme is being delivered by BDUK (part of the Department for Digital, Culture, Media and Sport - DCMS).

The Scheme operates across the whole of the United Kingdom of Great Britain and Northern Ireland (the “**UK**”).

The purpose of the Scheme is to increase the speed of deployment of full fibre networks within the UK by providing micro-grants to support the cost of new connectivity. Vouchers are the mechanism the Scheme uses to provide these grants. The Scheme aims to encourage Suppliers to invest in gigabit capable services. The voucher is a benefit to eligible Small and Medium Enterprises (**SMEs**) and in some circumstances residents (together being “**Beneficiaries**”) who must receive the full value of the voucher.

These grants have a minimum value of £500 and a maximum value of £2,500, for each SME Beneficiary. The Scheme provides support for businesses that qualify as SMEs. Using their grant, SMEs contract with registered suppliers for Gigabit-capable products (referred to by the Scheme as “Pre-Registered Packages” (PRPs)). These PRPs must be registered separately by suppliers using the “Pre-Registered Package Application”. There is no mechanism by which a grant may be obtained other than through a PRP.

In certain specified circumstances support is also available to support the cost of connections for resident Beneficiaries. Details are provided in the Pre-Registered Package Application document. These vouchers have a value of £500 and support the cost of new connections costing £500 and above and must be part of Project PRPs where the ratio of residential to business vouchers is no greater than 10:1.

Payments of the grants to eligible Beneficiaries under the Scheme are made by DCMS direct to registered suppliers, once they have confirmed that new connections have been delivered and the Beneficiary has accepted service.

Following the precedent of the BDUK Super-Connected Cities Voucher Scheme, payments for vouchers issued through the Scheme to SMEs are made under the terms of the European Commission's “De-Minimis” Regulation (1407/2013).

This document sets out the qualifying criteria for suppliers who wish to register for the Scheme, and also contains the core terms and conditions of the Scheme which all suppliers must formally accept as part of their registration.

BDUK will make additional guidance about the operation of the Scheme available.

The application has two sections:

Part A contains the terms and conditions for participation

Part B contains your application information and agreement.



You MUST read and agree:

1. Supplier Registration Statement
2. Connectivity Requirements
3. Eligible Costs
4. Scheme Marketing and Promotion Protocol
5. Issue Escalation Procedure

When you have read Part A (in this document) you should complete Part B online.

Part B also allows you to provide company and contact information for subsequent publication on the Scheme web portal.

When you have satisfactorily registered as a supplier for the Scheme, we will make application documents for Pre-Registered Packages available to you.

The terms and conditions associated with Pre-Registered Packages are available to you now. You should also read these before you apply. You may only participate in the Scheme by agreeing a PRP with us.

Effective date of these updated terms and conditions

Version 4.0 of these terms and conditions supersedes and replaces version 3.0 of these terms and conditions with effect from 17:00 on 26 November 2018, except that:

1. the changes made in version 4.0 of these terms and conditions (which are highlighted in Supplier Bulletin number 8) shall not apply retrospectively;
2. for Project PRPs which either (i) have already been received or approved by BDUK prior to 09:00 on 12 November 2018; or (ii) are new and are received by BDUK prior to 17:00 on 7 January 2019, the Tier 1 Changes shall take effect from 1 January 2020 in respect of such Project PRPs; and
3. for new Project PRPs received by BDUK after 17:00 on 7 January 2019, the version of these terms and conditions that is in force at that time shall apply in respect of such Project PRPs.

As an alternative to 2(ii) above, suppliers may at their discretion submit:

1. new Project PRPs during the period from 09:00 on 12 November to 17:00 on 26 November for consideration by BDUK provided that the Project PRPs comply with version 3.0 of these terms and conditions as amended by the Tier 1 Changes; and
2. new Project PRPs during the period between 17:00 on 26 November 2018 and 17:00 on 7 January 2019 provided that the Project PRPs comply with version 4.0 of these terms and conditions (including the Tier 1 Changes).

For the purpose of these terms and conditions, "**Tier 1 Changes**" means the following changes in version 4.0 of these terms and conditions: (i) any voucher value now being £2,500 that was previously £3,000; the requirement for the ratio of residential to SME vouchers to be no greater than 10:1; and (iii) the requirement for the voucher contribution to 'active' equipment used by suppliers to be capped at a maximum contribution of £500 per voucher.



Part A – Terms & Conditions

Section 1

Supplier Registration Statement

All suppliers are required to read the following declaration and sign and date the form to confirm agreement:

1. I wish to register as a supplier for the Department for Digital, Media, Culture and Sport (DCMS) Gigabit Broadband Voucher Scheme (the “**Scheme**”).
2. I understand that I will be required to separately provide details of the eligible products that I wish to offer as part of the Scheme, using the “Pre-Registered Package Application”.
3. The information on this form, and any other information given in support of the application, is correct to the best of my knowledge.
4. I understand that providing wrong or deliberately misleading information may give rise to criminal or other legal consequence and may lead to the de-registration of suppliers from the Scheme using the Issue Escalation Procedure set out at Section 5.
5. I understand that the payment mechanism and operating mechanism for the Scheme are described within Section 2 of the Pre-Registered Package Terms and Conditions and in the “Guidance for Suppliers” document (provided separately as guidance only). If suppliers have any queries about whether claims comply with the requirements of Pre-Registered Package Terms and Conditions and the “Guidance for Suppliers”, they must provide any queries to DCMS without delay to ensure that any claim is compliant **before** submission.
6. I confirm that my organisation is capable of entering into contractual relationships with eligible SMEs and residents (“**Beneficiaries**”) for the delivery of connections.
7. I understand that non-participation (such as the continued refusal to offer services to Beneficiaries when requested, without reasonable explanation or cause) may be considered a breach of the terms and conditions of the Scheme and will be managed in accordance with the Issue Escalation Procedure as set out in Section 5.
8. I confirm that my organisation is registered for VAT.
9. I confirm that I am not a sole trader.
10. I confirm that I hold annual public liability insurance of at least £5m per event.
11. I confirm that all contracts offered to Beneficiaries supported by vouchers as part of the Scheme will have a minimum contract period of 12 months, and no free periods and/or discounts against standard monthly (recurring) charges shall be offered to Beneficiaries.
12. I confirm that I am **wholly** responsible for ensuring that all claims for payment of funding under the Scheme are only in respect of genuinely incurred Eligible Costs as set out in Section 3 only



and that every connection for which claims are made will comply with the “Connectivity Requirements” as set out in Section 2 of this document.

13. I confirm that Eligible Costs claimed will be consistent with those charged to customers without the benefit of voucher support. For the avoidance of doubt, a Supplier will be in breach of the Scheme Terms and Conditions if they make claims for eligible costs as set out in Section 3 which are greater than those which otherwise would have been charged to the Beneficiary had a voucher not been in place.
14. I understand that DCMS may amend the Scheme process and conditions set out in this and associated documents (including the PRP terms and conditions) from time to time. I will be notified in advance with details of any proposed changes and will be given the option to accept the proposed changes or de-register from the Scheme.
15. I agree that DCMS may contact references named in this application in support of my application for supplier registration in the Scheme.
16. Suppliers should note that local bodies involved in Wave 1 – Market test phase of the Scheme will continue to support DCMS in compliance and other matters. DCMS has appointed a third party to undertake on site and other compliance checks on behalf of DCMS.
17. I understand that DCMS gives no undertaking or accepts any liability for the ability or willingness of individual Beneficiaries to enter into contracts with suppliers for the supply of services, or for the authority of individual Beneficiaries to authorise connections at specific premises. Suppliers are advised to exercise usual due diligence best practice before entering into contractual agreements with Beneficiaries.
18. I understand that suppliers choose to participate in the Scheme (including provision of services and offers of contract) at their own cost and risk. DCMS cannot bind Beneficiaries into contractual relationships with suppliers.
19. DCMS’s agreement to the use of a Pre-Registered Package as part of the Scheme is not a guarantee of funding support. DCMS will only make financial provision to support the cost of any voucher when it is reported as “issued” by DCMS in accordance with the terms described in Section 2 of the Pre-Registered Packages Terms and Conditions.
20. I understand that, as part of DCMS anti-fraud procedures, supplier quotes, contracts and invoices will be subject to random audit. In addition, at the sole discretion of DCMS, any services provided may be subject to further clarification or inspection for the purposes of audit. Where further clarification is required by DCMS, its appointed agents and/or local bodies, **suppliers will be required to provide evidence that costs against which voucher funding has been claimed have been legitimately incurred and relate to Eligible Costs only (as set out in Section 3 - including evidence (where requested by DCMS) of input costs from the relevant wholesale infrastructure provider as identified in Section 2, paragraph 8 of this document.** Upon request, this information should be provided by suppliers within 5 working days. Where appropriate, DCMS will follow the Issue Escalation Procedure as described in Section 5 of this document.

- 
21. I understand that where DCMS and/or local bodies suspect or identify fraud, malpractice or supplier error and have carried out the steps described in the Issue Escalation Procedure in Section 5, DCMS reserves the right to withdraw or recover voucher funds from the supplier in question and/or remove the supplier from the Scheme at its absolute discretion.
 22. I understand that DCMS reserve the right to suspend the Scheme at any time and will not provide funds to support any vouchers for orders placed after the date of any such suspension. Notification of suspension of the Scheme will be to the main contact provided above. You must notify DCMS at LFFNsuppliers@culture.gov.uk in the event of any change of main contact details.
 23. I understand that the Scheme operates within the requirements of EU and UK competition law and as such I recognise that any anti-competitive behaviour (e.g. bid rigging) can be prosecuted by the relevant competition authorities. Where breaches of that law are found, the competition authorities have the power to levy fines against the company and bring criminal actions against individuals (in addition to director disqualification orders).
 24. I understand that the information provided on this form may be made available to participating local bodies, DCMS agents and the European Commission for purposes connected with the LFFN programme but will not otherwise be disclosed to third parties without express permission, except where required by law (including under the Freedom of Information Act 2000).
 25. I understand that DCMS does not offer any opinion on the capability of my organisation and I agree that I will not make representations to that effect.
 26. I understand that I must inform DCMS immediately of any change in circumstances which may affect this application in relation to this Scheme.
 27. I agree to provide DCMS with such additional information and assistance as DCMS may reasonably require from time to time in relation to the operation of the Scheme.
 28. I agree that if my organisation receives any information request under the Freedom of Information Act 2000 that concerns the Scheme and/or DCMS I shall provide such request to DCMS without delay.
 29. I understand that these terms and conditions shall be subject to and construed in accordance with English law and subject to the exclusive jurisdiction of the courts of England and Wales. The rights and remedies of DCMS under or in connection with these terms and conditions may be waived only by notice by DCMS and in a manner that expressly states that a waiver is intended.

30. PERSONAL DATA

- 30.1. DCMS and the supplier shall in relation to the Scheme comply with their respective obligations under (i) Regulation (EU) 2016/679 of the European Parliament and of the Council of 27 April 2016 on the protection of natural persons with regard to the processing of personal data and repealing Directive 95/46/EC (General Data Protection Regulation) OJ L 119/1, 4.5.2016 (being GDPR); (ii) the Data Protection Act 2018; (iii) any code of practice or guidance published by the ICO and/or the European Data Protection Board from time to time; and (iv) all other applicable data protection laws ("**Data Protection Laws**"), in each case to the extent necessary under those laws.
- 30.2. DCMS and the supplier acknowledge that:



- 30.2.1. the supplier shall provide contact data of relevant supplier personnel for use by DCMS in its administration, management, and operation of the Scheme (including for determining eligibility for the Scheme and (where applicable) for the purposes of monitoring, assurance, and fraud prevention) ("**Supplier Contact Data**");
 - 30.2.2. DCMS shall provide contact data of relevant DCMS personal for use by the supplier in its administration of, and participation in, the Scheme (including for the purpose of receiving vouchers) ("**DCMS Contact Data**"); and
 - 30.2.3. the supplier shall provide other Personal Data (including contact data of referee organisations and Beneficiaries) for use by DCMS in its administration, management, and operation of the Scheme (including for determining supplier eligibility for the Scheme) ("**Other Supplier Data**"). These data shall include but not be limited to: beneficiary contact name, installation address, email address, company number where relevant, date of agreement, current and planned broadband connection speed, date of order, date of installation.
- 30.3. In these terms:
- 30.3.1. "**Contact Data**" means the Supplier Contact Data or the DCMS Contact Data, as applicable; and
 - 30.3.2. "**Controller**", "**Personal Data**", "**Process**" and "**Processed**" have the meanings given to those terms in the Data Protection Laws.
- 30.4. For the purpose of the Scheme DCMS and the supplier agree that:
- 30.4.1. the Supplier shall be the Controller of:
 - 30.4.1.1. the Supplier Contact Data and the Other Supplier Data for its own internal business purposes; and
 - 30.4.1.2. the DCMS Contact Data where it is Processed by the Supplier in accordance with clause 30.2.2;
 - 30.4.2. DCMS shall be the Controller of:
 - 30.4.2.1. the DCMS Contact Data for its own internal business purposes;
 - 30.4.2.2. the Supplier Contact Data where it is Processed by DCMS in accordance with clause 30.2.1; and
 - 30.4.2.3. the Other Supplier Data for: (i) its own internal business purposes; and (ii) the purpose of its administration, management, and operation of the Scheme.
- 30.5. DCMS and the supplier shall Process the other party's Contact Data for the purposes set out above in accordance with that party's relevant privacy policy. Each party may be required to share the other party's Contact Data referred to above with its affiliates and other relevant parties, within or outside the country of origin, in order to carry out the activities specified above, but in doing so, each party will ensure that the sharing and use of the Contact Data complies with the Data Protection Laws.

- 
- 30.6. Where acting as the Controller for the purposes of the Contact Data, DCMS and the supplier shall make available to the other a copy of their applicable privacy policy and the receiving party shall ensure that this policy is provided to the applicable persons whose Personal Data has been shared with the other party for the purposes set out in these terms.
- 30.7. Where acting as the Controller for the purposes of the Other Supplier Data, the supplier shall ensure that all fair processing notices have been given (and/or, as applicable, consents obtained) and are sufficient in scope to allow the supplier to disclose the Other Supplier Data to DCMS in accordance with the Data Protection Laws for its use as anticipated in these terms.
- 30.8. DCMS and the supplier warrants, represents and undertakes to the other that it is not subject to any prohibition or restriction which would prevent or restrict it from disclosing or transferring its Contact Data or (in the case of the supplier) the Other Supplier Data in accordance with these terms.
- 30.9. The supplier shall indemnify on demand and keep indemnified DCMS against any losses incurred by, awarded against or agreed to be paid by DCMS to the extent arising from the supplier's failure to comply with the Data Protection Laws.



Section 2 - Connectivity Requirements

The following Connectivity Requirements form a key part of the Scheme Terms and Conditions. You must read and agree to these as part of your application to become a registered supplier on the Scheme.

All connections supported by vouchers must fulfil **BOTH** of the following characteristics:

- 1) be **capable** of delivering broadband connectivity at the Beneficiary's premises **at or above 1Gbps upload or download** at the time of delivery of the connection without the need for future hardware upgrades or modification (excluding Customer Premises Equipment (CPE) – it is not mandatory to deploy 1Gbps capable CPE from the outset if this is not required to deliver service, unless the CPE is embedded into the Network Terminating Equipment (NTE) which must be Gigabit capable); and
- 2) **deliver** a minimum of 100Mbit/s to the Beneficiary's premises. The upgraded broadband service must deliver a “step change” in service which, for the avoidance of doubt, is at least a doubling of speeds compared to the service currently being consumed.

Any premise with an existing connection already **capable** of 1Gbps or above in either direction is **NOT** eligible to benefit from a voucher whether or not that connection is currently in use.

“Capable” means capable of delivering 1Gb connectivity using any technology. Speeds are upload or download, not necessarily at the same time. Connections which use wireless technology to meet the Connectivity Requirements will **only** be permitted where included as part of an agreed Project Pre-Registered Package and which leads to the deployment of additional full fibre.

In order to be eligible for this Scheme, once the final connection has been made to a Beneficiary's premise and the Beneficiary is taking services, the supplier must confirm that the infrastructure supporting their service is capable of delivering 1Gb connectivity to a Beneficiary within 10 working days of a valid retail/wholesale upgrade order (or the minimal timescale which may be achieved due to external regulatory constraints) with no additional capital/infrastructure/passive equipment upgrades required (excluding CPE).



Section 3 - Eligible Costs

Introduction

For the purpose of the Scheme "**Eligible Costs**" means the full, or the significant part of, the **directly attributable incremental costs** (that are capable of being capitalised under generally accepted accounting practices in the UK) of connecting Beneficiaries to commercially deployed access infrastructure to enable Beneficiaries to obtain the high-speed / high-grade service capability they require, which meet the connectivity requirements set out in Section 2 and as such costs are further described in this Section 3.

In particular, vouchers can be used by the Communications Provider (CP) to provide customers with a step-change in service, which can be obtained either through the provision of new connectivity using LFFN qualifying NGA Networks (including the use of wired or wireless technologies) [see Note 1 below] or the provision of business grade connectivity (leased line capability/microwave) [see Note 2 below]

The likely eligible incremental costs of providing the access connection are described in this document.

In accordance with these terms and conditions of the Scheme, suppliers are responsible for ensuring that all claims submitted for voucher funding relate to Eligible Costs only, and should seek further guidance from DCMS if necessary before submitting claims for payment.

Broadly, the lines of demarcation in the network that qualify for subsidy are:

- **Network side:** The downstream port of the nearest point of significant aggregation to a customer's Network Terminating Equipment (NTE); and
- **Customer side:** the customer-side ports (or wireless antenna) of the Network Termination Equipment (NTE) to which a Network Communicating Equipment (NCE) is connected.

This is further illustrated by reference to the diagrams below, which apply these demarcation principles to various types of network deployment:

1. Typical Deployment (Fibre)

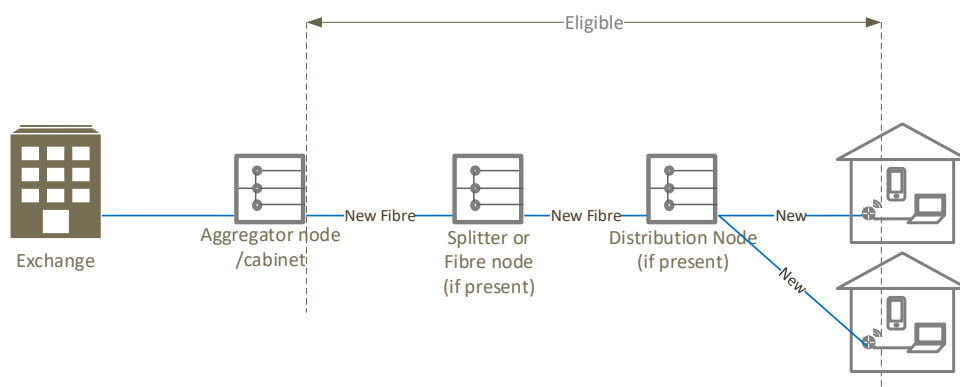



2a Example Deployment (Wireless)

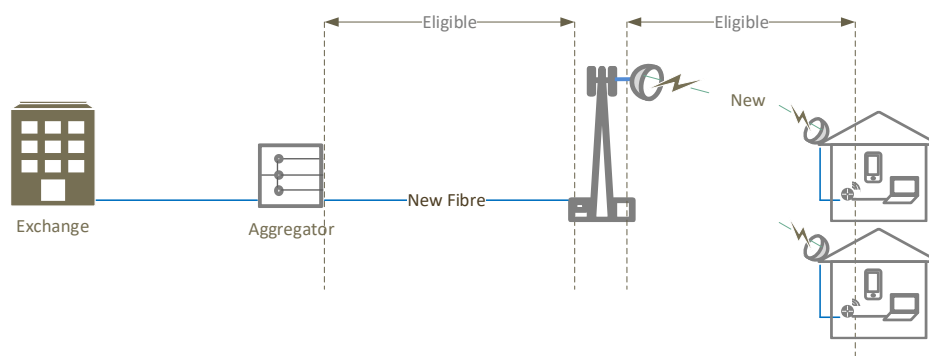

2b Example Deployment (Wireless)

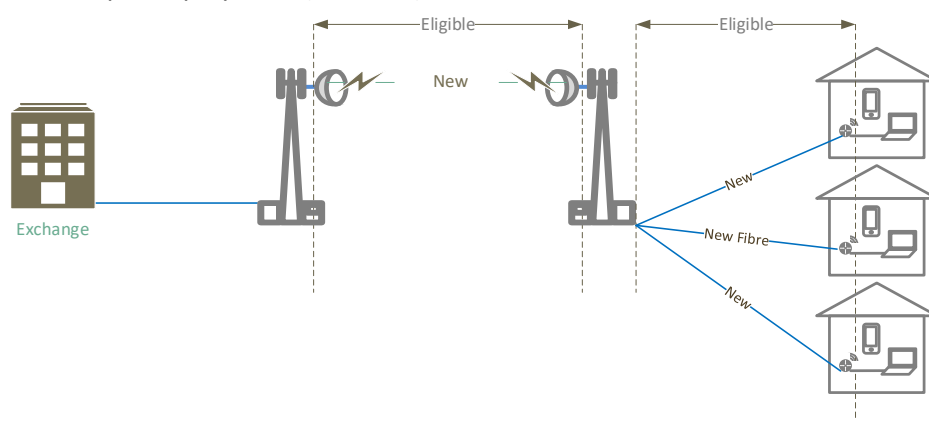

2c Example Deployment (Wireless)

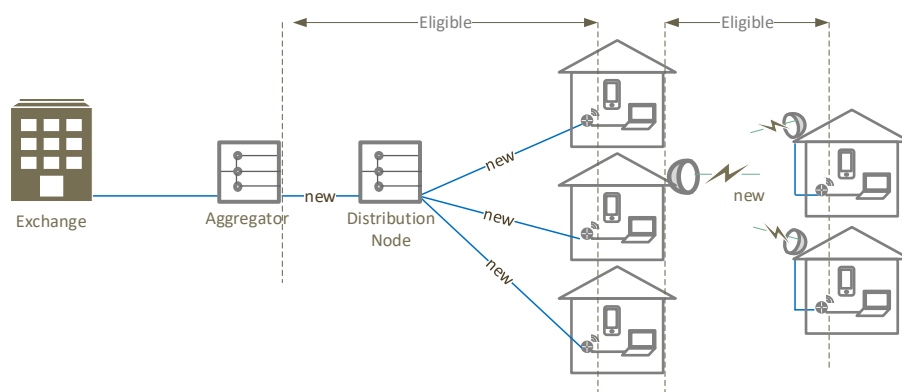

Passive and powered splitters/combiners, amplifiers, repeaters and regenerators which do not provide a switching/routing function that are within these lines of demarcation **qualify for subsidy**, as do other intermediate items that are required to provide the requisite service, as described below.

Customer Premises Equipment (CPE) or NTE devices which provide a general computing function beyond supporting a network data service **do not qualify** for subsidy, including most NCE devices, firewalls, telephones, tablets, laptops and PCs. By contrast CPE devices that **only** provide a networking function, including modems, qualify. Only one wireless access point as part of the CPE may qualify. The maximum contribution made to the cost of any CPE by the voucher is £250 ex VAT. 4G dongles, or internal 4G modules for laptops, do not qualify. In addition to the cap of £250 for



CPE, the contribution made by a voucher to the costs of active switching equipment for multi-occupancy buildings or sites is capped at **£500** ex VAT per voucher (i.e. a total maximum contribution of £750 for CPE and active equipment).

While the precise categories of permitted expenditure will be dependent on the solution offered to the Beneficiary the following categories of Eligible Costs are intended to provide suppliers with an indication of the **likely** qualifying items.

DCMS reserves the right at its absolute discretion to deem any cost ineligible as part of a standard or project PRP proposal where that cost is inconsistent with the Scheme's aim of supporting new gigabit capability in the UK.

Eligible costs

The costs set out below are non-exhaustive examples of Eligible Costs.

Eligible network connection costs (for all types of connection)

- planning, survey, acquisition, site preparation, installation, and commissioning fees. Note that the maximum contribution made by the voucher for the costs of any survey works is **£250** ex VAT;
- provision of building entry points and (including breaking/drilling charges for entry through external and internal walls), trunking and tray work (within end-user's curtilage) and fibre cable and jointing;
- necessary supporting structures including poles and other mountings, brackets, fixings, and associated civil works (including craneage);
- power supplies equipment to support network electronics and optics, including power company connection costs, but excluding any CPE power supplies beyond an existing 240V AC socket;
- fibre optic cables, sheaths, connectors, joints, splitters and enclosures,, microwave feeders, jumpers, connectors, antenna radomes and enclosures, lightning protection devices, and electrical earthing systems;
- adapters/converters to ensure that all the pre-existing communications functionality is effectively maintained (e.g. adapters/converters for analogue telephones, dialup modems, alarm diallers or other devices that may contain embedded modems such as medical alarms)

Eligible business connectivity (fibre) connection costs (for fixed connections only)

- provision of new footway and carriage boxes, poles and duct infrastructure;
- CPE (e.g. Optical Network Terminal (ONT) or fibre modem), backup battery, patch panel and residential gateway and associated intermediate power and fibre communications cables).

Eligible Network connection costs (wireless solutions only)

- provision of building location points (including all associated mounting costs);
- Radio Frequency (RF) connectors, splitters, combiners, duplexers, duplexers, filters, antennas, radomes and enclosures;
- External wireless repeaters if necessary for coverage; and
- provision of building location points (including all associated mounting costs); and
- wireless CPE costs.



Excluded costs

The following costs are non-exhaustive examples of costs that do not qualify as being Eligible Costs:

- SME connections to basic broadband technologies[[note 4](#)];
- bonded VDSL connections
- additional charges for expedited connection e.g. time related charges (TRCs);
- cancellation fees for any pre-existing connection or contract;
- cabling on the customer side of the CPE to support (e.g. in-premise installation of cat5e and RG6 coax cable or more than one wireless access point);
- inter-site connectivity;
- historic capital costs associated with network deployment (excepting where these have been demonstrably deployed at risk by the CP in anticipation of Beneficiaries using vouchers to access the network since the launch of the Scheme);
- any of the network elements that may require upgrading to support the final connection e.g. 'middle' mile/trunk and core upgrades that are required to support the final connection;
- costs related to the purchase of wayleaves or other easement rights [[note 3](#)];
- operational expenditures and overheads (Opex), save for those that are direct incremental and one-off costs associated with the installation of the new high-speed / high-grade connection;
- operating lease rentals, general corporate or unabsorbed overheads, interest and financing charges;
- wayleaves;
- demand surveys, marketing & other sales costs.

Explanatory Notes Section 2 & 3:

[1] NGA Networks are access networks which rely wholly or partly on optical elements (coaxial, wireless and mobile technologies make use, to a certain extent, of a fibre support infrastructure, thereby making them conceptually similar to a wired network using copper to deliver the service for the part of the last mile not covered by fibre) and which are capable of delivering broadband access services with enhanced characteristics as compared to existing basic broadband networks. (The final connection to the end-user may be ensured both by wired and wireless technologies. Given the rapid evolution of advanced wireless technologies such as LTE-Advanced and the intensifying market deployment of LTE and Wi-Fi, next generation fixed wireless access (e.g. based on possibly tailored mobile broadband technology) could qualify as NGA Networks. Next generation wireless access based on tailored mobile broadband technology must also ensure the quality of service level required by the customer at a fixed location while serving any other nomadic subscribers in the area of interest. Wireless technologies are only permitted when included as part of an agreed Project Pre-Registered Package and which leads to the deployment of additional full fibre.

[2] Business grade services being those uncontended capabilities connecting a SME site to a point in the supplying communications provider's network (e.g. partial private circuits or microwave link) and are supported with service level guarantees.

[3] Wayleave and easement rights being payments made to landowners for the legal right to access that land in order to install and maintain communications cabling and piping. For example, see Openreach charges for connection at: <https://bit.ly/1Ly71hV>

[4] Several different technology platforms can be considered as basic broadband networks including asymmetric digital subscriber lines (up to ADSL2+ networks), non-enhanced cable (e.g. DOCSIS 2.0), mobile networks of third generation (UMTS) and satellite systems.



Section 4 – Scheme Marketing and Promotion Protocol

DCMS Media Protocol for suppliers participating in the Scheme

This protocol aims to ensure there is clear understanding of how suppliers should present their involvement in the Scheme, how media enquiries should be handled, and when announcements need to be flagged to all parties involved.

Media Enquiries:

Suppliers will respond to all local and regional specific enquiries as they are best placed to provide this information. General questions about nationwide government programmes should be directed to DCMS by contacting our general enquiries email at enquiries@culture.gov.uk. Suppliers may respond to questions relating to the specific work they are undertaking and general broadband enquiries. When responding to queries or promoting the scheme suppliers should state the contribution being made by DCMS, and when doing so may use our logo and branding in accordance with the guidance below. Any material disseminated by a supplier with DCMS or UK Government branding or logos must be signed off by us before release. The sign-off process is to send all proposed documents for release to LFFNSuppliers@culture.gov.uk.

Social Media:

DCMS press team are keen to support announcements through social media and ministers are happy to re-tweet where appropriate. If space permits and where appropriate, we would encourage DCMS funding to be referenced in tweets and social media content, linking to DCMS social media accounts on Twitter (@dcms) and Facebook (facebook.com/dcmsgovuk). To help us join up, we suggest suppliers follow us on Twitter and like us on Facebook so we can follow them back and also look out for retweets and content to share.

Press Releases:

All parties (DCMS, relevant suppliers, and local bodies and devolved administrations if applicable) need to approve, and be offered an opportunity to provide a quote for inclusion in, any press release relating to the following:

- Supplier registration
- Projects and connections commenced or delivered
- Any other significant milestones being reached

All press releases or public announcements will need to be signed off by BDUK and DCMS. The sign-off process is to email all press releases to LFFNSuppliers@culture.gov.uk. Individual suppliers should ensure BDUK is included in any communications regarding press releases which ensures BDUK and DCMS are sighted on all activity and can agree the release. BDUK and the DCMS press office do not want to slow down the procedure, and would not normally look to comment, but will need to sign off any planned comms activity unless you are advised otherwise.

Any press release regarding the scheme must state the contribution being made by UK Government GBVS logo.



Use of Logos/Brands and References to the Scheme

DCMS will make logos available for registered Suppliers taking part in the Scheme through the Scheme portal. These may be found at <https://gigabitvoucher.gov.uk/media> and are only accessible to users with log on access to the site.

The following guidelines **must** be followed when using these logos or references to the Scheme:

- The use of the logo must not imply any endorsement of one supplier over another.
- The logo must be of equal size to other partners' logos.
- Relevant suppliers with registered products may present them to their customers as "available with support from DCMS".
- Registered suppliers must NOT present themselves or any Pre-Registered Package (PRP) products as "approved" by DCMS nor infer that DCMS agreement to a Project PRP implies any sole supplier rights for the relevant location.
- The logos may not be used following the end of the Scheme/programme or the cessation of your involvement in it.
- Placement of the logos must not imply any other accreditation or support of the supplier or its products other than the agreed Scheme.
- DCMS reserves the right to have a quote included in any press release associated with the Scheme/programme.

Suppliers should **only** describe their involvement in the Scheme as "Registered Supplier" and any PRPs as "agreed". Further guidance and examples of how to use these logos, can be found on the programme's portal to which Registered Suppliers will be given access.

The right for suppliers to use the logos are under a non-exclusive licence only and do not confer upon suppliers any right or interest in the logos other than as set out in these terms. Logos should be used only as provided through the Scheme portal.

Suppliers must not do, nor cause or authorise to be done: (i) anything which shall impair, damage or be detrimental to the reputation or goodwill associated with DCMS, the Scheme, the LFFN programme and/or the logos; or (ii) anything which may adversely affect the value of the logos or their registration. The logos shall not be altered in any way without prior written consent from DCMS and the suppliers shall ensure that any reproduction under these terms shall be a true and exact replica of the relevant logos.

You authorise DCMS to use your organisation's logo on the Scheme website and to link to your organisation's website.

Any breach of these conditions of use may trigger the scheme Issue Escalation Procedure – see Section 5



Section 5 – Issue Escalation Procedure

The following procedure will be followed if there are issues arising with suppliers in respect of the Scheme including, but not restricted to:

- Provision of PRP proposals, quotes or invoices which have been identified as suspicious by DCMS anti-fraud procedures.
- Provision of quotes or invoices which seek to secure voucher funding for costs which have not been genuinely incurred or are not Eligible Costs as defined in Section 3.
- Provision of invoices for costs which are not consistent with commercial rates for comparable installations.
- Instances of suspected collusion between suppliers.
- Any other suspected breaches of terms and conditions of the Scheme or in the additional PRP terms and conditions.

Following an initial investigation by DCMS and/or the local body, or DCMS's appointed agent, without prejudice to any rights or remedies of DCMS at law or in contract one of the courses of action listed below will be followed.

- 1) Do nothing – DCMS assessment determines that no further action is required.
- 2) Monitor – DCMS assessment determines that the supplier(s) in question should be monitored for an agreed period of time before determining if action is required.
- 3) Investigate – DCMS determines that further investigation of the issue is required. The DCMS Senior Responsible Officer (SRO) will be notified.

Suppliers should note that, should DCMS reasonably believe that public funding may be at risk, then DCMS reserves the right to immediately suspend suppliers from the Scheme (and cease further payments to that supplier) pending further investigations.

If further investigations are deemed necessary as part of (3) above, the supplier will then be contacted in writing by DCMS and asked to provide clarification of the issue within five working days of receipt of DCMS notification.

On receipt of the supplier's response, the supplier may be invited to attend a meeting with DCMS and/or the relevant local body to discuss the nature of the issue and the clarifications received.

Following completion of investigations (which may involve further discussions with the supplier) a written report will be prepared by DCMS. Depending on the specific nature of the issue, without prejudice to any rights or remedies of DCMS at law or in contract the course of action that DCMS may take may include any or all of:

- No action required – case closed;
- DCMS issuing clarification of guidance to all local bodies;
- DCMS issuing clarification of guidance to the supplier(s) concerned;
- DCMS issuing updated guidance to all suppliers;
- DCMS amending the design of the Scheme;
- DCMS determining special measures for the supplier(s) in question, such as an increased frequency of audits;
- DCMS removing the supplier(s) from participation in the Scheme;

- 
- DCMS seeking to recover Gigabit voucher funds from the supplier(s) concerned or administering other sanctions on the supplier, as deemed appropriate (such as referring the supplier to the relevant authorities).

Suppliers will have a right of appeal to the BDUK Chief Executive, if required. Otherwise, any decision made by DCMS under this escalation procedure shall be final.

Issues relating to other schemes

In the event that there are issues arising with any supplier in respect of any other DCMS programme or scheme (including without limit the Local Full Fibre Networks programme, the Superfast programme and the Better Broadband Scheme), including issues analogous to the issues described in this section 5, such that DCMS reasonably believes that public funding may be at risk, then DCMS reserves the right at its discretion to (having completed an investigation) suspend the supplier from the Scheme, remove the supplier from the Scheme, apply special measures to the supplier (such as an increased frequency of audits) in respect of the Scheme and/or recover Gigabit voucher funds from the supplier paid under the Scheme. DCMS may exercise such rights whether or not there are issues arising with the supplier in respect of the Scheme and such rights shall be without prejudice to, and unaffected by, any rights DCMS may have under or in connection with those other programmes or schemes.



PART B – Application & Agreement (online)

1. Suppliers are reminded that, in order to participate in the Gigabit Broadband Voucher Scheme, they must meet all of the following conditions:
 - Be able to supply Gigabit Capable connectivity (as set out in Section 2 of Part A)
 - At the date of application, have already provided Gigabit capable connectivity (which meets the requirements of the Scheme) to customers within the UK
 - Agree to the terms and conditions set out in Part A
 - Agree to submit at least one Pre-Registered Package application to DCMS for review (Stage 2 of this application process)
 - Hold membership of at least one Ofcom listed Alternative Dispute Resolution scheme (see below)
 - Provide the declaration below

2. Supplier Capability Statement (online questions provided here for information only)

THIS IS NOT A FORM – you must complete the online form.

1.	Please confirm that you are able to offer eligible connections to Beneficiaries (as set out in Section 2 of Part A).	Yes/No
2.	Please confirm that you have already delivered Gigabit capable connectivity (which meets the connectivity requirements of the Scheme) on a commercial basis within the UK. Please note that you may be required to provide evidence.	Yes/No
3.	Are you a member of a recognised telecoms industry trade body? If yes, please provide details below (4), including membership number, date of registration, and trade body details. Please list all that apply or state none.	Yes/No
4.	Trade Body Details	DATA
Guidance	<p>If your answer to 3. above is none, you must provide details of two referees.</p> <p>One referee must be a business customer to whom you have provided broadband services (meeting the connectivity requirements of the Scheme) in the last 3 months.</p> <p>The other referee should be a wholesale or infrastructure provider you intend to use to deliver eligible connections as part of the Scheme.</p>	
5.	Business Reference: Organisation	DATA
6.	Business Reference: Contact Name	DATA
7.	Business Reference: Contact Email	DATA
8.	Business Reference: Contact Telephone	DATA
9.	Wholesale/infrastructure Reference: Organisation	DATA
10.	Wholesale/infrastructure Reference: Contact Name	DATA
11.	Wholesale/infrastructure Reference: Contact Email	DATA
12.	Wholesale/infrastructure Reference: Contact Telephone	DATA

Guidance	All registered suppliers must be a member of an Ofcom-recognised Alternative Dispute Resolution (ADR) service. Please provide details below of the ADR service of which you are a member.	
13.	ADR Service Details	DATA
14.	The Scheme supports the use of the Ofcom “Business Broadband Speeds Code of Practice” - please confirm whether you currently subscribe to this code?	Yes/No
Guidance	https://www.ofcom.org.uk/data/assets/pdf_file/0034/85768/business_broadband_code_2016.pdf	
15.	If your response to 14 is NO, do you plan to subscribe to the code?	Yes/No
16.	If 15 is YES, by what date?	DATE
17.	In order to deliver services under the Scheme, are you intending to self-supply connections?	Yes/No
Guidance	If you are intending to provide Gigabit capable connections using a wholesale infrastructure provider, please provide details of the relevant wholesale infrastructure providers(s) with whom you have a commercial relationship. This must include details of the organisation(s) ultimately responsible for provision of Gigabit capable infrastructure. Please list all and any relevant reference/account numbers:	
18.	LIST Infrastructure Providers you intend to use as part of the Scheme	LIST
19.	If OTHER selected at 18 provide details here	DATA
Guidance	Please note that, as part of the Scheme’s value for money controls, you may be required to provide evidence of wholesale input cost from the relevant infrastructure provider to support claims for voucher funding.	

3. DECLARATION

CONFIRM AGREEMENT

I confirm that I have read, understood agree to be bound by the terms and conditions set out in:

1. Supplier Registration Statement
2. Connectivity Requirements
3. Eligible Costs
4. Scheme Marketing and Promotion Protocol
5. Issue Escalation Procedure

You must confirm when you submit your application online.